

# SPECIFICATION

## Product picture: 3650SR model

### Front:



### Back:



# Contents

- 1. **General**-----3
- 2. **Main product specification**-----3
- 3. **Environmental condition**-----3
- 4. **Electrical characteristics**-----4
  - 1).Input characteristics-----4
  - 2).Output characteristics-----4
  - 3).Protection characteristics -----5
  - 4).Status(LED) indicator -----5
  - 5).Control Status-----5
- 5. **Safety & EMC**-----6
- 6. **Environmental testing requirements**-----7
- 7. **Mechanical characteristics**-----7
  - 1).Input terminator diagram & definition-----8
  - 2).Output terminator diagram & definition-----8
  - 3).WEIGHT: (ABOUT 4.0 Kg) ----- 8
- 8. **Package, transportation & storage** ----- 8
- 9. **Reliability requirements**-----9
- 10. **Charger wiring** -----9
- 11. **Interlock fuction**-----9
- 12. **Label**----- 10
- 13. **Charging Curve** -----10

## 1. General

Power supply 3650SR is cooled by 80\*80\*25mm 12VDC ball-bearing fans Forced air, can work normally under 44.0Vdc/25A, Reverse Protection.



## 2. Main product specification

Max. output power	Input voltage	Output voltage	Output current range	Combined regulation
1100W	115Vac/230Vac	44.0+/- 0.2Vdc	24-26	±0.2V

## 3. Environmental condition

No.	Item	Technical specification	Unit	Remark
1	Humidity	5%-95%		With package
2	Altitude	≤3000	m	Work normally
3	Cooling	The power supply is cooled by 80*80*25mm 12VDC ball-bearing fans Foreed air		Working under full load

## 4. Electrical characteristics

1 Input characteristics				
No.	Item	Technical specification	Unit	Remark
1.1	Rated input voltage	115/230	Vac	115Vac/230Vac select switch
1.2	Input voltage range	90-132/180-264	Vac	
1.3	AC input voltage frequency	47-63	Hz	
1.4	Max input current	17	A	Vin=115Vac, rated load Fitted with 30A/250V

				slow burn ceramic fuse
--	--	--	--	------------------------

<b>2 Output characteristics</b>				
<b>No.</b>	<b>Item</b>	<b>Technical requirements</b>	<b>Unit</b>	<b>Remark</b>
2.1	Fast charge voltage	44.0+/- 0.2	Vdc	
2.2	Floating voltage	41.4	Vdc	
2.3	Constant current	25	A	
2.4	Switch current	5	A	
2.5	Power efficiency	≥80%		Vin=220Vac, rated load
<b>3 Protection characteristics</b>				
<b>No.</b>	<b>Item</b>	<b>Technical requirements</b>		<b>Remark</b>
3.1	Output over voltage protection		V	
3.2	Software over voltage protection	The charger software limits the maximum output voltage to a level suitable for the connected battery system		
3.3	Thermal cutback	An internal temperature monitor reduces charger output power in extreme operational temperature to prevent damage		
3.4	Output current limiting protection	27A	A	@CC MODE
3.5	Output short circuit protection	Short circuit protection should automatically recover after removing the fault.		
3.6	Electronic reverse battery protection	The charger is electronically protected against permanent reverse battery connection		
3.7	Cell short circuit timer	Internal software protection		
<b>4 Charger (LED) indicator</b>				

No.	Item	Status LED	Remark
1	Deep charge	LED fast flash twice	
2	Fast charging	LED Fast flash, once every 0.5 second	
3	Floating charge	LED ON ALWAYS	
4	Completely Charge	LED ON ALWAYS	

## 5. Safety & EMC

No.	Item		Standard (or testing condition)	Remark
1	Electric strength test	Input—output	1500Vac/10mA/1min	No breakdown
2	Isolation resistance	Input—ground	$\geq 10M\Omega @ 500Vdc$	
		Output—ground	$\geq 10M\Omega @ 500Vdc$	
3	Leakage current		$< 3.5mA$	$Vin = 264Vac, 50-60Hz$
4	SAFETY		UL / c UL/ CE compliant	
5	EMC	RE	CLASS B	EN55014
		CE	CLASS B	EN55014
		Air discharge	LEVEL 3	EN61000-4-2(discrimination B)
		Contact discharge	LEVEL 3	EN61000-4-2(discrimination B)
		RS	LEVEL 3	EN61000-4-6(discrimination A)
		CS	LEVEL 3	EN61000-4-3 (discrimination A)
		EFT	LEVEL 3	EN61000-4-4 (discrimination B)
		Surge	LEVEL 3	EN61000-4-5, differential module 1 KV, common module 2KV(discrimination B)

Remark: Discrimination A— function OK under technical requirement range; discrimination B--function temporarily debased without reposition and halt is allowed; discrimination R— physical damage or failure of equipment are not allowed, but damage of protection device (fuse) caused by

interference signal of outside is allowed, and the whole equipment can work normally after replacement of protection device and reset of running parameter.

### 6. Environmental testing requirements

No.	Item	Technical specification	Remark
1	High temperature ambient operating	+40deg.C	Features ok
2	Low temperature ambient operating	-10 deg.C	Features ok
3	High temperature storage	+70 deg.C	Work normally after recovery under normal temperature for two hours
4	Low temperature storage	-40 deg.C	Work normally after recovery under normal temperature for two hours
5	Random Vibration	20Hz to 2000Hz 3Grms 20hours per axis	
6	Repetitive Shock	40g peak 3 orthogonal axes,3+ and 3- in each axis ,11ms Pulse width	
7	Thermal shock:	-35 deg.C to +75 deg.C,<3minute transition,2.5hour dwell,200cycle	
8	Drop test:	BS EN60068-2-32:1993 Test Ed:Free fall,appendix B	

### 7. Mechanical characteristics

**Outline dimension** (Unit: mm) length×width×height=270×150×87 mm

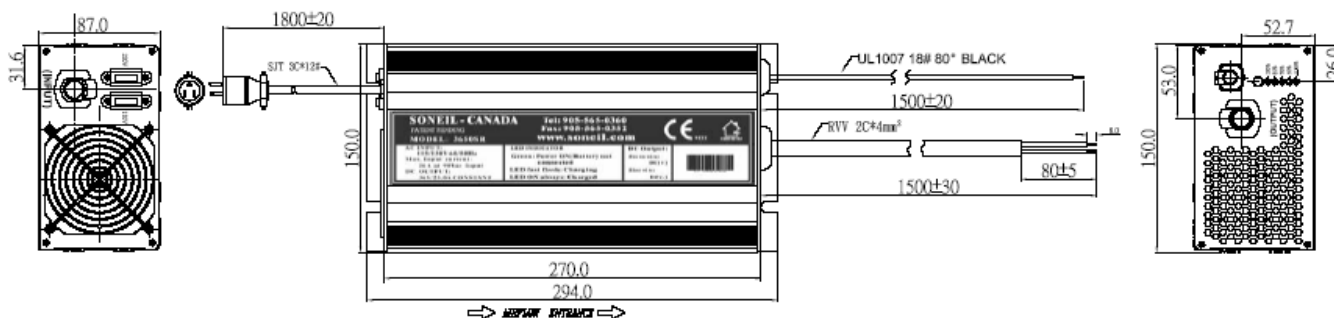

Tolerance of outline dimension is ±0.5mm, others are ±0.2mm in the diagram;

#### 1)、Input terminator diagram & definition (AC input wire)

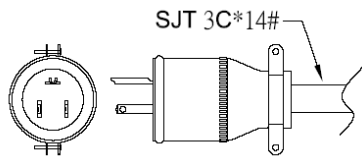

## 2)、 Output terminator diagram & definition (DC output wire)

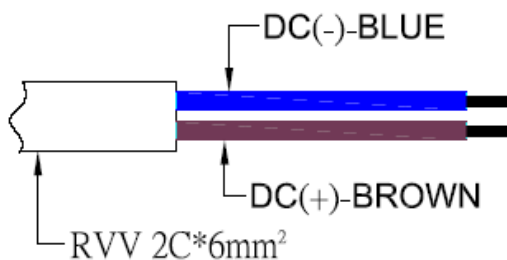

## 3)、 Output terminator diagram & definition (Interlock wire)

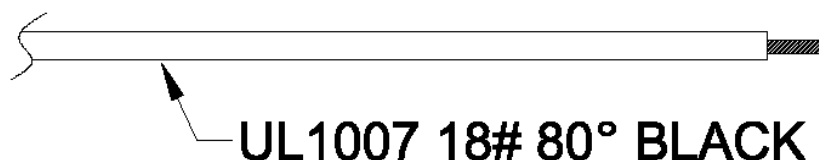

## 3)、 WEIGHT: (ABOUT 4.0 Kg)

## 8. Package, transportation & storage

### 1)、 Package

There are product name, model, name of manufacturer, safety approval, serial number on the label and User/Operation Manual in the packing box.

### 2)、 Transportation

Suitable for transportation by truck, ship, and plane. The products should be shielded by tent from sunshine, and loaded and unloaded carefully.

### 3)、 Storage

Products should be stored in packing box when not used. And warehouse temperature should be  $-40\text{deg.C}$ — $+70\text{ deg.C}$ , and relative humidity is 5%—95%. In the warehouse, there should not be harmful gas, inflammable, explosive products, and corrosive chemical products, and strong mechanical vibration, shock and strong magnetic field affection. The package box should be above ground at least 20cm height, and 50cm away from wall, thermal source, and vent. Under this requirement, product has 1 year of storage period, and should be rechecked when over 1 year.

## 9. Reliability requirements

## Reliability

MTBF (standard, environmental temperature, load requirement)  $\geq 15$  Khour ; testing condition: 25deg.C, full load, testing proved value. **(1 year full warranty)**

## 10.Charger wiring

The basic power wiring for the charger is shown in figure 2

1)、 A spark is often seen on first connection of the charger to the battery terminals due to charging of the internal output capacitors ,This is Normal and should not lead to undue concern ,care should be taken to ensure the battery vent caps are closed and there are no flammable object in the vicinity of where the connection will be made

2)、 The charger has been calibrated to take account of the voltage drop in the DC output cables during operation, To prevent the possibility of over or under charging of the battery it is recommended the DC output cables are connected directly to the battery without modification. Soneil is able to customize cable lengths and connections for volume customers with specific requirements.

## 11. Interlock function

**Normal operation of the relay:**

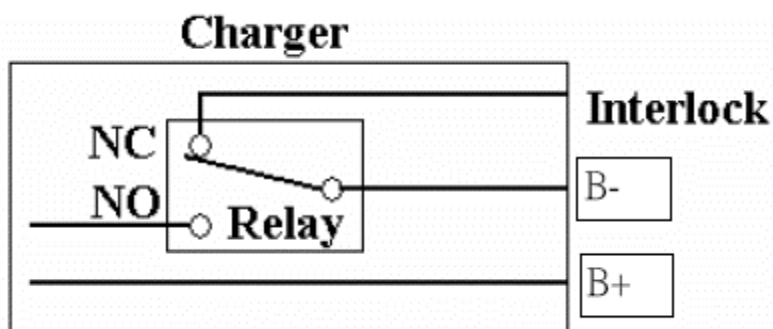

1. **Relay has to be AC activated\*(turn on when AC is plugged-in)**
2. **Relay has to be NC(Normally Closed) when AC is ON**
3. **Relay has to be OPEN when AC is OFF**



\*The charger has a third output wire for interlock function.This will prevent the electrical vehicle motor, head lights etc. from functioning when the batteries are being charged.The





Interlock wire is internally connected to a relay, which connects to the B-cable inside the charger( see diagram)

### 12. Label

<b>SONEIL - CANADA</b> PATENT PENDING <b>MODEL: 3650SR</b>		Tel: 905 565 0360 Fax: 905 565 0352 <b>www.soneil.com</b>				 <small>IN DOOR USE ONLY</small>
<b>AC INPUT:</b> 115/230V 60/50Hz <b>INPUT CURRENT:</b> 17.0A@115Vac 8.5A@230Vac <b>DC OUTPUT:</b> 36V/25.0A CONSTANT	<b>LED INDICATOR</b> Green: Power ON/Battery not connected LED fast flash: Charging LED ON always: Charged	<b>DC Output:</b> Brown wire: DC(+) Blue wire: DC(-)	<b>Series Number:</b> 3650SR GDTA3301			

**CAUTION :**

- Risk of electric shock. Do not expose to liquid, vapor or rain.
- Charge only lead-acid type rechargeable batteries. Other types of batteries may burst causing personal injury and damage.
- For continued protection replace only same type and rating fuse:(T30A H 250V).







### 13.Charging Curve

Refer to Attachment

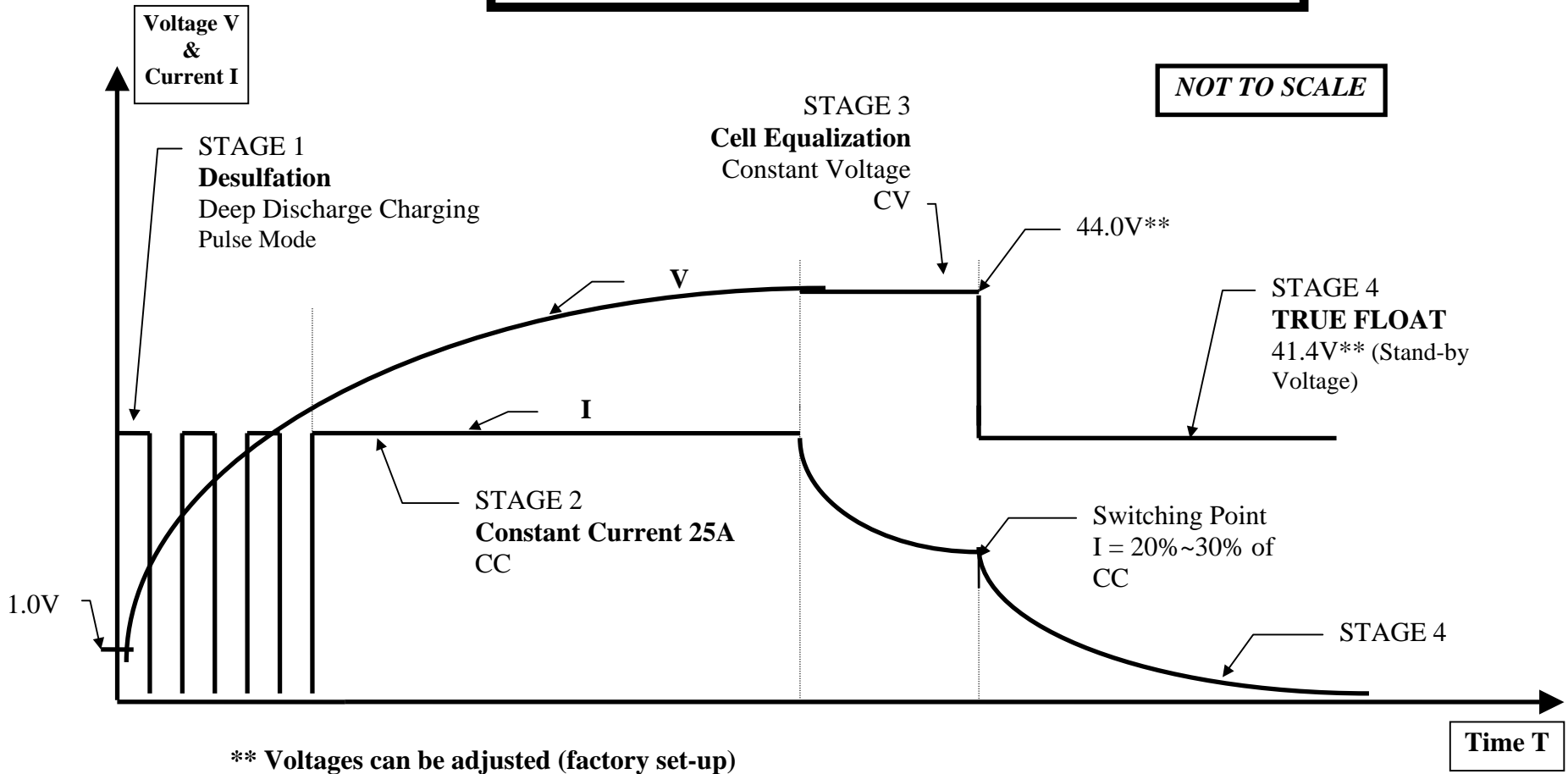
# CHARGING CURVE MODEL 3650SR

SONEIL 36V/25A CHARGER



Ref: Curve3650SR.23Sept05